

DRYCOOL™ HD

OPERATING MANUAL

Warranty Safety Installation Operation Maintenance

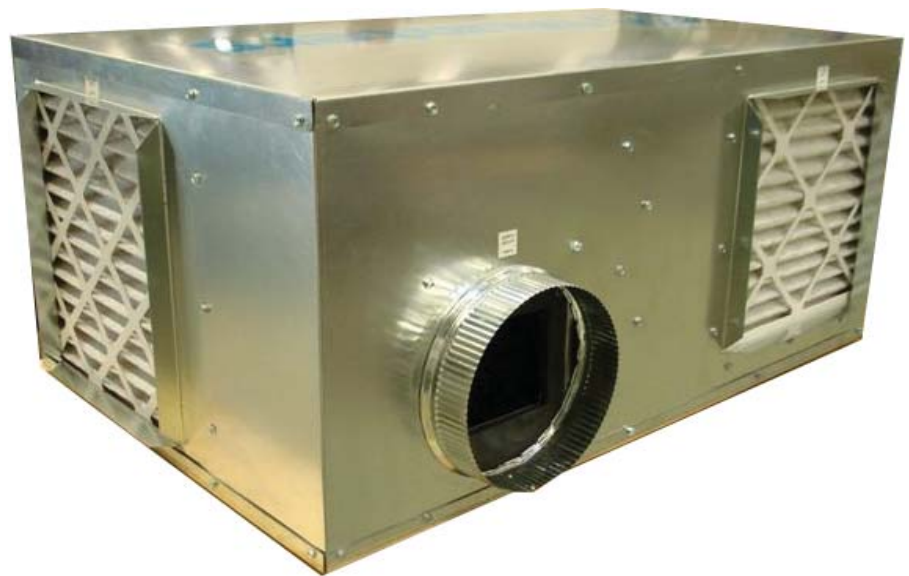

Residential and Light Commercial
Desiccant Dehumidifier/220V
February 2013

Table of Contents

1.	Introduction	1
1.1.	Technical Description	1
1.2.	Desiccant Wheel Operating Principle	2
1.3.	Intended Application	3
1.4.	Specifications	4
1.5.	Limited Warranty	5
2.	Safety	6
3.	Installation	7
3.1.	Pre-Installation Requirements	7
3.2.	Pre Checks and Inspection before Installation	7
3.3.	Ducting for Dehumidification	10
3.4.	Installation in Basement or Crawl Space with Existing Forced Air HVAC	12
3.5.	Installation in an Attic with Existing Forced Air HVAC	13
3.6.	Installation for Dehumidification for a Stand Alone Space	13
3.7.	Humidistat Installation Requirements	14
3.8.	Condensate Removal	15
3.9.	Optional Germicidal UV Light	15
4.	Operating Instructions	17
4.1.	Controls	17
4.2.	Sequence of Operation	17
5.	Maintenance and Service	18
5.1.	Standard Air Filter	18
5.2.	Filter Instructions	18
5.3.	Germicidal UVC Lights	19
5.4.	UV Light Change and Safety Warnings	19
5.5.	Troubleshooting	19
5.6.	Recommended Maintenance Schedule	20
6.	Appendix: Unit Specific Information	22
	Unit Specific Information – Wiring Diagram, Sound Level Measurements, Fan Curves, Dimensional Drawing	

1. Introduction

This manual includes installation, operation, and troubleshooting instructions for the DryCool™ HD desiccant dehumidifier. The unit provides significant drying capability in a small package and utilizes a refrigerant circuit in conjunction with a heat reactivated desiccant wheel to provide an efficient drying capability. Due to the substantial capabilities of the desiccant wheel, the unit can continue to provide low supply dew point conditions.

The hybrid desiccant refrigeration cycle provides the most efficient small dehumidifier available. In addition, the supply air is discharged at approximately space neutral temperature so that it does not add additional cooling load to the space.

1.1. Technical Description

The DryCool™ HD uses a refrigeration system similar to an air conditioner to remove heat and moisture from the incoming air. In addition a HoneyCombe® desiccant wheel downstream of the evaporator coil removes further moisture from the airstream in a vapor state.

The desiccant wheel is operated with two separate air streams. The supply air stream is pulled from the conditioned space and in controlled amounts from outside. The reactivation air stream is generally taken entirely from outside. See **Figure 1** below.

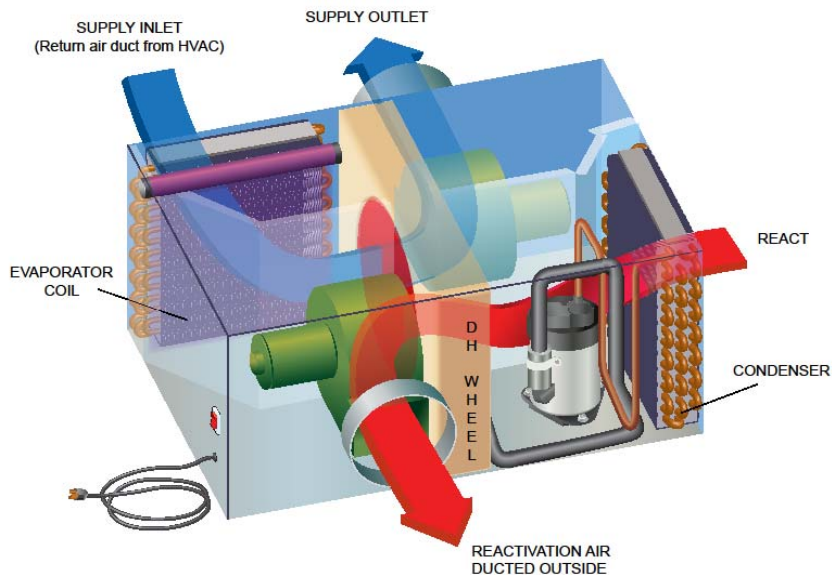

Figure 1: DryCool™ HD Operating Principle

Within the closed circuit refrigeration system hot - high pressure refrigerant gas is routed from the compressor to the condenser coil. Here the refrigerant is cooled and condensed by giving up its heat to the passing air. This heated air is used to reactivate the desiccant wheel. The heat applied to the wheel allows moisture to be driven off and discharged by the reactivation fan. Thus the reactivation air needs to be ducted to the outside.

The refrigerant liquid then passes through a filter - drier and capillary tubing which causes the refrigerant pressure and temperature to drop. It next enters the evaporator coil where the refrigerant absorbs heat from the incoming air. The compressor then draws the cool refrigerant gas and compresses it to a high pressure and temperature to repeat the process.

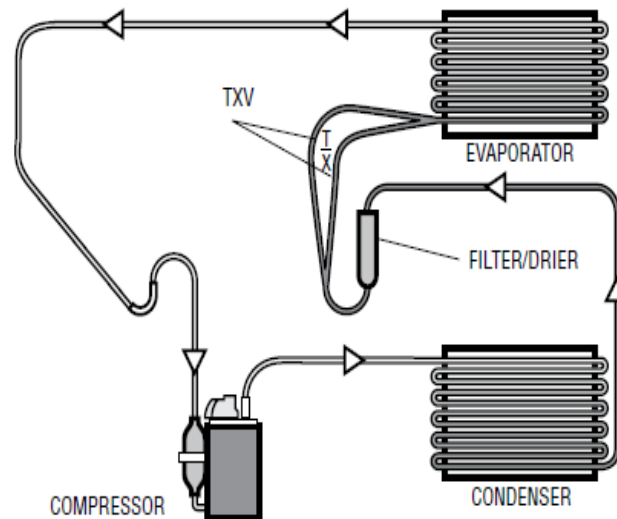

Figure 2: Refrigeration System of DryCool™ HD

The DryCool™ HD operates cost-effectively because all of the energy required for the operation of the desiccant dehumidifier cycle is recovered from the refrigeration components. The system utilizes a humidistat to cycle the capacity on when the humidity in the space is high and to cycle the capacity off when the space humidity is at the desired condition.

Some benefits include, energy efficient and affordable dehumidification; environmentally friendly refrigerant R-410a, compact size for installations in small spaces, assists in the prevention of mold, mildew and other bacteria, low maintenance cost and fresh air ventilation.

1.2. Desiccant Wheel Operating Principle

1. The “Heart” of the DryCool™ HD system is the Desiccant wheel. The wheel has a series of air passages or channels arranged in a honeycomb pattern. The honeycomb material is nonmetallic and does not react to bacteria. The passages inside the wheel are impregnated with a desiccant material, such as silica gel.
2. When damp air is pulled through the supply air section of the wheel and contacts the desiccant it removes moisture in a process known as “adsorption”. The removal of moisture causes the air to warm due to the heat of vaporization of water in the air.
3. As the wheel rotates the stored moisture is moved from the supply air path to the reactivation air path. Heated air in the reactivation air path passes over this section of the wheel, releasing large amounts of moisture. We say the desiccant is “reactivated”. This process is constant as the desiccant wheel is continually rotating.
4. See Sequence of Operation for a logic description of the DryCool™ HD desiccant dehumidifier.

To avoid the problems often caused by moisture and create a comfortable environment, a dehumidifier is required or necessary to maintain relative humidity between 40-50% throughout the environment. Only supplemental dehumidification provides indoor humidity control regardless of air conditioner operation or outside moisture conditions.

1.3. Intended Application

The DRYCOOL™ HD Dehumidifier is intended for installation in spaces that experience short or long term high humidity conditions. The DRYCOOL HD is not suitable for pool areas. Use of the unit in pool areas will void warranty. In order to efficiently control humidity levels, the area in which the dehumidifier is to be placed must be free of water intrusion or excessive fresh air infiltration. Before installation, water intrusion or excess air infiltration should be addressed. See **Figure 3** for unit detail, inlet and outlet, supply and connection information.

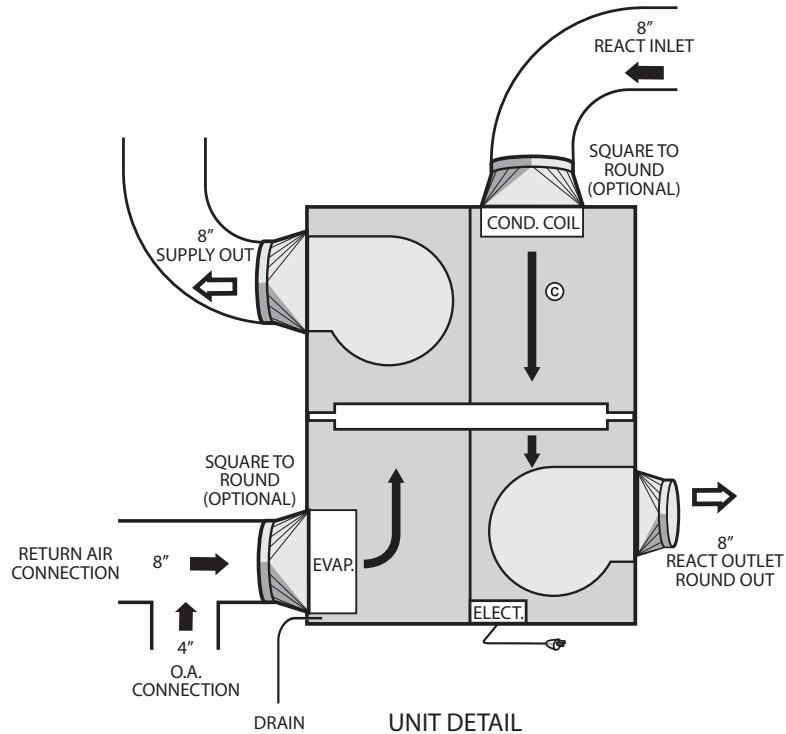

Figure 3: DryCool HD Dehumidifier - Unit Detail

- DO NOT use unit as a bench or table.
- DO NOT place unit directly on structural members.
- A secondary drain pan **MUST** be placed under the unit.

The DRYCOOL™ HD should be located near the existing air handling system to minimize the required ductwork. The controls are remote from the unit and must be located in the space that is to be conditioned. The controls are low voltage (24 volt) and should be connected with low voltage thermostat wire.

If fresh air ventilation is desired, thought should be given to the location for the fresh air ducting. A 4”(10.16cm) round insulated duct will have to be installed on the unit and run to the outside of the structure to bring in fresh air. **The unit is not meant to condition more than 75 cfm of outside air.** Consult local codes for necessary distances from exhaust ports when installing fresh air return.

1.4. Specifications

1.4.1. DryCool™ HD Dehumidifier Specifications

Model	DRYCOOL™ HD
Electrical	220V / 50 Hz
Capacity	120 Pints/day @ 80° F (26.66° C) / 60% RH
Operating Current	3.5 Amps/Power consumption at full load
Power	0.7kW - 0.8kW (Depending on load)
Efficiency	3.3 L/kW (7 Pints/kW)
Operating Temp	Conditioned Space Limits: 45° F - 95° F (7.22 – 35° C)
	Reactivation Inlet Limits: 40° F – 100° F (4.44 – 37.77° C)
Installed Location Temp	* External Ducted : 40° F – 140° F (4.44 - 60° C)
	** Unducted Reactivation : 40° F – 100° F (4.44 – 37.77° C)
Air Flow	250CFM (See fan curves supplied in appendix)
Supply Air Temp	Space Neutral (± 3° F) (± 16.11° C)
Refrigerant	Refrigerant Charge 28 oz. (0.793kg) R410
Unit Size	24 L x 36 W x 16.5 H (60.96 x 91.44 x 41.91cm)
Unit Weight	135 lbs. (61.234kg)
Shipping Weight	150 lbs. (68.038kg)
Optional Filtration	Merv 7 - Standard, Merv - 13 Optional
	Electrostatic Filter (Option - No Longer Available)
	* External Ducted: Reactivation and process air inlets are externally ducted. ** Unducted Reactivation: Reactivation air comes from the surrounding air.

Table 1: DryCool™ HD Dehumidifier Specifications

1.4.2. DryCool HD Performance and Psychrometric Advantage

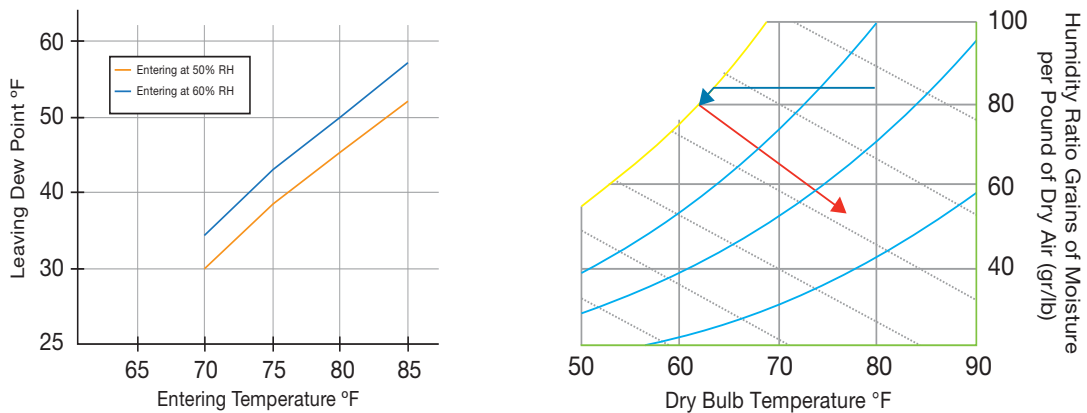

1.5. Limited Warranty

WARRANTY FOR MUNTERS DEHUMIDIFICATION EQUIPMENT, SYSTEMS AND PARTS

Your Munters DRYCOOL™ HD Dehumidifier is expressly warranted for a period of one (1) year from date of purchase. This warranty extends to the original end user and may not be assigned to or transferred. Munters warrants that for one (1) year after the date of original purchase the DRYCOOL™ HD Dehumidifier will operate free from any defects in materials and workmanship. Munters exclusive obligation under this warranty will be to supply, without charge, a replacement part for the dehumidifier which is found to be defective within a one (1) year period from the date of purchase and which is returned not later than thirty (30) days after said one (1) year period to Munters DRYCOOL™, Selma, TX together with proof of purchase of the dehumidifier.

THIS WARRANTY SHALL NOT OBLIGATE MUNTERS CORPORATION FOR ANY LABOR COSTS AND SHALL NOT APPLY TO DEFECTS IN WORKMANSHIP OR MATERIALS FURNISHED BY YOUR INSTALLER AS CONTRACTED TO DEFECTS IN THE DEHUMIDIFIER ITSELF.

IMPLIED WARRANTIES OF MERCHANTABILITY OR FITNESS FOR A PARTICULAR PURPOSE SHALL BE LIMITED IN DURATION TO THE AFORESAID ONE YEAR PERIOD. MUNTERS CORPORATION'S LIABILITY FOR INCIDENTAL OR CONSEQUENTIAL DAMAGES, OTHER THAN DAMAGES FOR PERSONAL INJURIES, RESULTING FROM ANY BREACH OF AFORESAID IMPLIED WARRANTIES OR THE ABOVE LIMITED WARRANTY IS EXPRESSLY EXCLUDED. THIS LIMITED WARRANTY IS VOID IF DEFECT(S) RESULT FROM FAILURE TO HAVE THIS UNIT INSTALLED BY A QUALIFIED HEATING AND AIR CONDITIONING CONTRACTOR. IF THE LIMITED WARRANTY IS VOID DUE TO FAILURE TO USE A QUALIFIED CONTRACTOR, ALL DISCLAIMERS OF IMPLIED WARRANTIES SHALL BE EFFECTIVE UPON INSTALLATION.

Some states do not allow limitations on how long an implied warranty lasts or the exclusion of limitation of incidental or consequential damages, so the above exclusions or limitations may not apply to you.

This warranty gives you specific legal rights and you may also have other rights which vary from state to state.

2. Safety

The contents of this manual include suggested best working practices and procedures. These are issued for guidance only and they do not take precedence over the individual responsibility and/or local safety regulations.

During installation and operation of this unit it is always each individual's responsibility to consider:

- Their own and others personal safety.
- The safety of the unit through correct use of the equipment in accordance with the descriptions and instructions provided in this manual and local/state safety guidelines.

Munters is concerned about the safety of all who use or services the DryCool™ HD desiccant dehumidifier unit. There are parts inside the unit that can be dangerous if an untrained person tries to service the unit. Throughout this manual, we have pointed out hazards that may occur in its. We have also listed the precautions necessary to avoid these problems.

It is recommended that the user be informed about the use of safety symbols used in this manual by reading the following information. The relevant safety information will be listed in each chapter or section.

This manual uses two different types of **warning** messages to alert you of possible hazardous conditions:

 WARNING	Hazard or unsafe practice that <u>may</u> result in severe personal injury or death.
--	---

 CAUTION	Hazard or unsafe practice that <u>could</u> result in minor personal injury or property damage.
--	--

Be aware of the following **warnings** while servicing the unit.

 WARNING	Only trained and qualified electricians should service the electrical components of this unit. Repair to electrical components by non-certified personnel may result in injury and/or damage to the unit.
--	--

 CAUTION	Installation should be conducted by a qualified technician only and Munters and Munters affiliates are not responsible for injuries and/or damages caused by improper installation.
--	--

 WARNING	Improper installation, adjustments, alteration, service or maintenance can cause property damage, injury or death. Read all installation, operating and maintenance instructions thoroughly before installing or servicing this unit.
--	--

NOTE	READ AND UNDERSTAND ENTIRE MANUAL. FOLLOW ALL INSTRUCTIONS AND READ MANUAL COMPLETELY. ENSURE ALL SAFETY INSTRUCTIONS AND PRECAUTIONS ARE FOLLOWED.
-------------	--

3. Installation

3.1. Pre-Installation Requirements

Please note the following items related to this unit and its installation must be completed prior to scheduling the factory technician for startup.

- All wiring (Power and Control), electrical components, control devices, and electrical service should be completed in accordance with **NFPA 70, NEC** (National Fire Protection Association, National Electrical Code). Wiring and components must also comply with all State and Local Code requirements along with installation plans and unit specifications.
- All venting, cooling, refrigeration, plumbing and piping should be installed per **UMC, ASHRAE** (Uniform Mechanical Code, American Society Heating, Refrigeration and Air Conditioning Engineers) requirements for building and energy efficiency. All components must also comply with all State and Local Code requirements along with installation plans and unit specifications.
- All air supply, ducting and connections must be completed per **UMC, AMCA, and SMACNA** (Uniform Mechanical Code, Air Movement and Control Association - International Inc, Sheet Metal and Air Conditioning Contractors National Association) specifications. All components must also comply with all State and Local Code requirements along with installation plans and specifications.

3.2. Pre Checks and Inspection before Installation

The unit must be lifted carefully with assistance as necessary. Personnel must be capable of lifting weight shown on dimensional drawing or Specifications **Section 1.4**. See **Appendix** for additional unit dimensions and weight. If a lift is used, please use spreader bars that are two - four inches wider than the unit width to prevent from squeezing the top of the unit. Failure to do so may damage the unit.

For proper mounting, review all drawings; dimensions, ducting, submittal package, notes on orientation and positioning and confirm this information before installing unit(s).

Noise control issues should be taken into consideration when installing unit. Modern roof and construction is normally lightweight. Where the DryCool unit is located over noise sensitive areas, noise may be a concern. Generally, the distance between the roof-mounted equipment and the closest occupied spaces below the roof is insufficient to apply standard sound control treatments.

A summary of sound level measurements are shown in the appendix. This information should be used as a reference point for noise control considerations prior to placing unit. Simple Slow Time Weighing and Slow Time Weighing Sound Level Equivalent charts for the Drycool HD™ can be viewed in the **Appendix**. Unit sound level measurements were taken with system operating in the Airlab at Munters/Amesbury. Background sound measurements were taken before and after testing and represent the ambient noise levels at the time the system was sound level tested.

Upon unit arrival, inspect immediately for signs of shipping damage. If you do notice any damage, report it to the shipping company and to Munters immediately.

1. Check all items in the shipment carefully against the bill of lading. Be sure all of the listed items have been received and none are missing.
2. Remove packing materials from unit to check the following items:
 - Unit is in position and evenly supported.
 - Unit is level.
 - Outside air is filtered before entering the building.
3. Check the electrical panels and controls:
 - Check for any signs of damage.
 - Check the tightness of all electrical connections. Carefully check the power wiring terminals.

3.2.1. Positioning the Unit

It is important that the intended installation site meets the location and space requirements for the unit in order to achieve the best possible performance and trouble-free operation.

 CAUTION	MAKE SURE THE UNIT IS LEVEL.
--	-------------------------------------

The appendix section shows the dimensional drawings for units. Allow specified clearances around the unit on all sides for maintenance access. A 2 ft. minimum is required. Units should have free access to all access panels and doors.

NOTE	The HD Unit should be installed with a minimum of <u>2 ft. clearance</u> around entire unit for panel cover access and replacing filters.
-------------	--

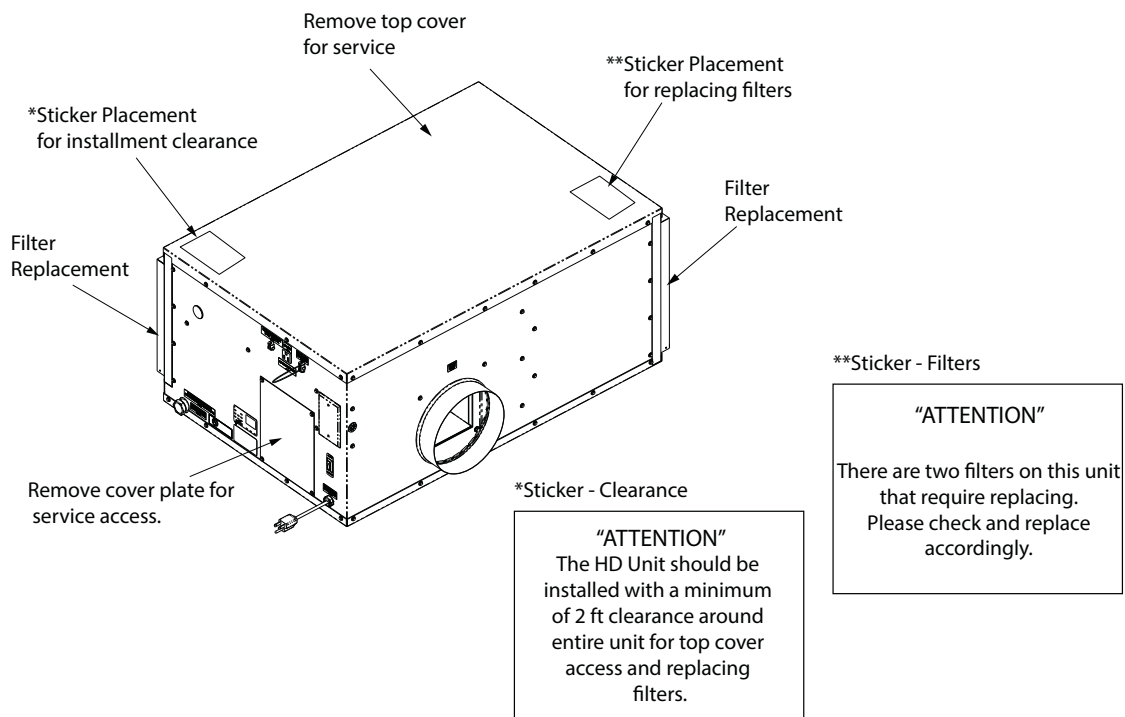

Figure 4: DryCool HD Dehumidifier – Install Minimum Space Requirements

3.2.2. Installation Requirement Checklist

Check all items in this listing to insure proper installation prior to unit startup.

1. Check all electrical service and wiring.
 - All electrical service must be provided to accommodate the unit MCA (Minimum Circuit Ampacity). It must be suitably protected against short circuit and ground fault by a suitable means using the MOP (Maximum Over current Protection).

NOTE

Please refer to additional wiring instructions provided on wiring diagram. See Figure 10.

2. Check and install all Duct connections.
 - Duct connections for supply and return air are adequate for the unit.
 - On supply discharge ductwork, allow for adequate length of 6 ft (182.88cm) or more of acoustical flex ducting on the outlet side is available. See the installation section for detailed information. Details on ducting standards can be found in **SMACNA** publication "HVAC Systems – Duct Design" and Chapter 18 of **2008 ASHRAE HVAC Systems and Equipment Handbook**.
3. Install and/or Check external piping, condensate drains, and drip pans make sure they are cleaned of any debris.

NOTE

The drain trap needs to be primed with water prior to start-up and after extended periods of unit shut down (winter months).

4. Install and/or Check approved "P" trap on cooling and drain pan as required per local installations.
5. Install all humidistat's; sensors, damper actuators, remote sensors and/or other humidity control devices. **Do not** install the humidistat where it may not accurately sense the relative humidity, such as near HVAC supply registers, exterior doors, or near a pool or spa.
6. Check installed ducting and connections for tightness.

3.2.3. Connecting Air Supply Duct

1. Air duct connections must be completed according to **U.M.C., A.M.C.A., S.M.A.C.N.A.**, and/or state and local code requirements. Refer to the plans and specifications supplied with the unit.
2. Where all flex-ducting is required be sure it is all UL listed. (This prevents ductwork from transmitting vibrations).

3.2.4. Connecting Electrical Service

The DRYCOOL™ HD plugs into a common grounded outlet on a 15 Amp circuit. It draws less than 4 Amps under normal operating conditions. If used in a wet area, a ground fault interrupter protected circuit is required.

If an extension cord is required, it must have a minimum of 16 gauge conductors if less than 25 feet (762cm) long, and 14 gauge if greater than 25 feet (762cm) long.

1. Check for any signs of damage.
2. Ensure all electrical connections are tight. Carefully inspect power wiring terminals.
3. Electrical service and control wiring must comply with NEC and/or state and local code requirements.
4. The DryCool™ HD desiccant dehumidifier uses a common grounded outlet on a 15 amp circuit. Be sure line voltage matches the voltage required by unit.

**CAUTION**

Be sure unit is properly connected to a power source with correct line voltage. Line voltage that is too high can cause a **SHOCK** hazard and damage unit. Correct line voltage is listed on electrical drawing.

3.3. Ducting for Dehumidification

The DRYCOOL™ HD Dehumidifier uses a unique arrangement of two air streams to accomplish the task of providing cool dry air at high efficiencies. These are a supply air stream and a reactivation air stream. The supply air stream is meant to dehumidify air for the space being controlled. The reactivation air stream expels the water vapor collected by the desiccant dehumidification wheel.

**CAUTION****MAKE SURE UNIT IS LEVEL.**

3.3.1. Supply Air Ducting

A 11.5" W x 12" H (29.21 x 30.45cm) square inlet located on the same side as an 8" (20.32cm) round outlet is the supply air intake for the unit. The square inlet can be connected directly to the return air duct coming from the central part of the structure. This duct should draw air from the central part of the structure and supply air to the isolated areas of structures like smaller rooms. Ductwork of the existing heating system can be used to supply air to the structure. If the existing supply goes to isolated areas of the structure, discharge the supply of the DRYCOOL™ HD unit into supply of the existing central system. DO NOT draw air directly from the kitchen, laundry, or basement. You may draw air from a basement that is open to the structure. All flexible ducting connected to the DRYCOOL™ HD unit should be UL listed.

The supply outlet of the DRYCOOL™ HD is located on the same side as the square supply inlet. A length of 6 feet (182.88cm) or more of acoustical flex ducting on the outlet of unit will reduce air noise from the blower. A length of flexible ducting on all DRYCOOL™ HD duct connections is recommended to reduce noise and vibration transmitted to rigid ductwork in the structure.

Ducting the DRYCOOL™ HD requires consideration of the following points:

Duct Sizing: For total duct lengths up to 25' (762cm), use a minimum 8" (20.32cm) diameter round or equivalent rectangular.

- For longer lengths, use a minimum 8" (20.32cm) diameter or equivalent. Grills or diffusers on duct ends must not excessively restrict air flow.

Isolated Areas: Effective dehumidification may require ducting be branched to isolated, stagnant areas. Use 8" (20.32cm) or larger diameter branch ducting to each of two or three areas; use 4" (10.16cm) or larger to each of four or more areas.

Connecting to existing HVAC systems: An 8" (20.32cm) check damper can be installed to prevent reverse flow through unit. If the DRYCOOL™ HD is ducted to supply of a high static air handler the check damper may be placed in the unit supply duct.

- When using the UV option, an 8' (243.84cm) long minimum supply air duct is required to be connected to the square inlet.

3.3.2. Reactivation Air Ducting

A separate set of duct connections are provided for the DRYCOOL™ HD dehumidifier for reactivation air. The reactivation air is meant to convey water vapor captured by the desiccant wheel away from unit and outside the structure.

The reactivation outlet connection is an 8" (20.32cm) round connection located on the opposite side of the 12"W x 13.5"H (30.45 x 34.29cm) square supply air inlet. For total duct lengths up to 25' (762cm), use a minimum 8" (20.32cm) diameter round or equivalent rectangular. The duct should be brought to an outside wall or louver so that "wet" reactivation air is expelled from the space and to the outdoors. Use a conventional dryer vent with back draft damper for penetrating wall if infiltration is a concern.

3.3.3. Fresh Air Ducting

Fresh air can be brought into the structure by connecting a duct from outside to the DRYCOOL™ HD unit inlet and by turning on the fan switch or activating the humidity control. The fresh air duct must be connected to the return air duct of the central air system upstream of the DRYCOOL™ HD Dehumidifier. (See **Figure 3** for air flow illustration).

Additional considerations are as follows:

1. Outside air is filtered before entering the building.
2. Outside air will be dehumidified before entering if unit is running in dehumidification mode.
3. Drawing air from outside and blowing inside aids in slightly pressurizing the structure. This helps prevent dirty and humid air from entering elsewhere.
4. Adequate exhaust fans are recommended in bath rooms and kitchen.
5. Reactivation outlet **must be separated 4' (121.92cm) minimally** from the Fresh Air inlet.

In cold climates or areas where the outdoor dew point is low at times, ventilation can be used to dehumidify the structure. This is accomplished by bringing the dry, low dew point air into the structure during these times. This approach is often more economical than running the dehumidifier to remove excess moisture from the structure.

In cold climates, it is critical to adequately ventilate to reduce the inside moisture content to avoid moisture accumulating in wall cavities. For example; in a house that experiences condensation on the interior surface of windows during the winter, increasing the amount of ventilation will often cure the problem.

The DRYCOOL™ HD is designed to move 250 cfm. An insulated 4" (10.16cm) diameter duct is generally sufficient to provide up to 75 cfm of outside air. Remaining 175 cfm of return air can be mixed with this fresh air and ducted into the supply intake of the DRYCOOL™ HD.

3.4. Installation in Basement or Crawl Space with Existing Forced Air HVAC

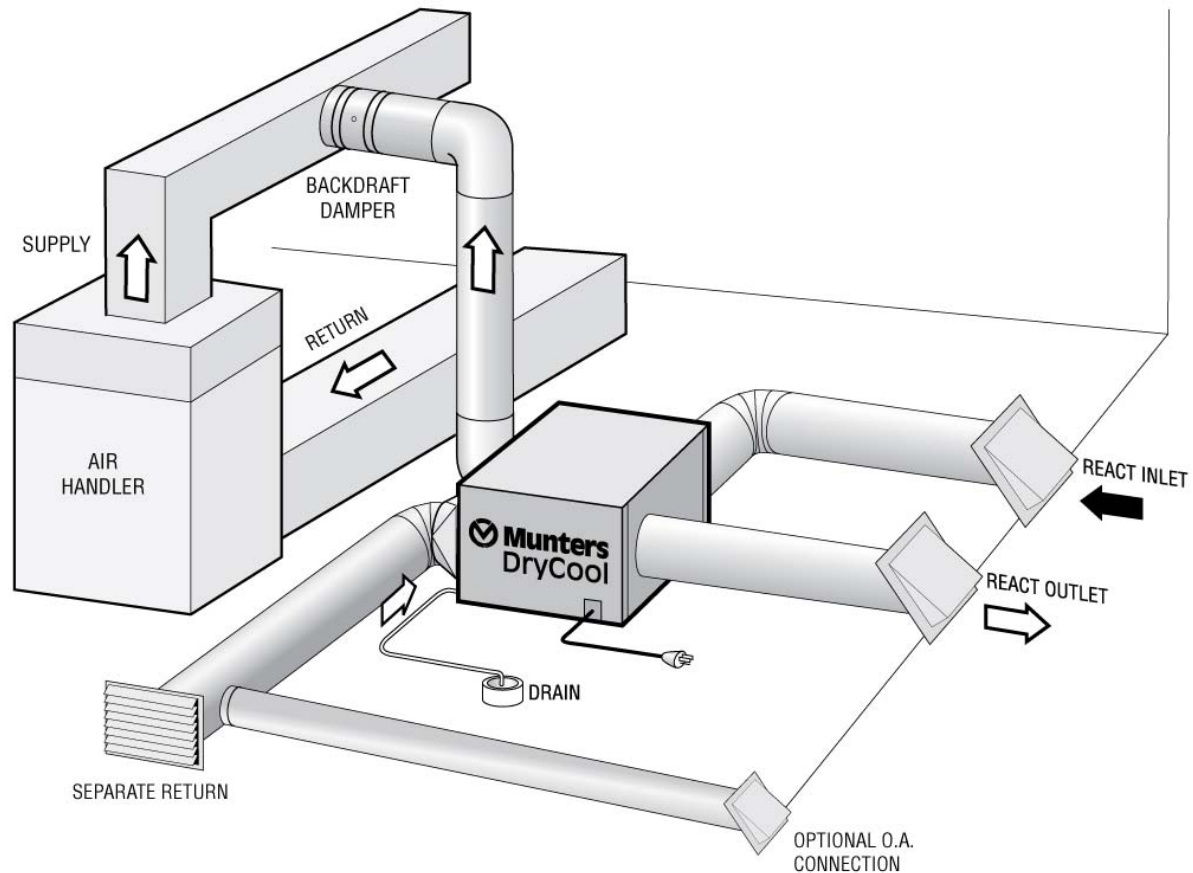

Figure 5: Conditioned Unventilated Basement Installation

Always select a return from a central location in the structure in an area that is always open to the rest of the structure.

Do not use a return from a room that often may have its door closed. If the structure in which the unit is to be installed has an existing forced air HVAC system, utilize the HVAC system to make the DRYCOOL™ HD unit installation easier.

Basement Installation: Install a separate 8" (20.32cm) return duct for the DRYCOOL™ HD in a central area of the structure. Duct the supply of the DRYCOOL™ HD to an 8" (20.32cm) x 8" x 8" tee/damper that is 20% open to the basement. Duct the other side of the tee to the air supply of existing HVAC system. Connect 8" (20.32cm) ducts to the reactivation inlet and outlet to supply ambient air for reactivation and to expel moist air outside the basement.

Crawl Space Installation: Install a separate return for the unit in a central area of the structure. Duct the supply of the DRYCOOL™ HD to an 8" (20.32cm) x 8" x 8" tee/damper that is 20% open to the crawl space. Duct the other side of the tee to the air supply of the existing HVAC system. Connect 8" (20.32cm) ducts to the reactivation inlet and outlet to supply ambient air for reactivation and to expel moist air outside the crawl space.

3.5. Installation in an Attic with Existing Forced Air HVAC

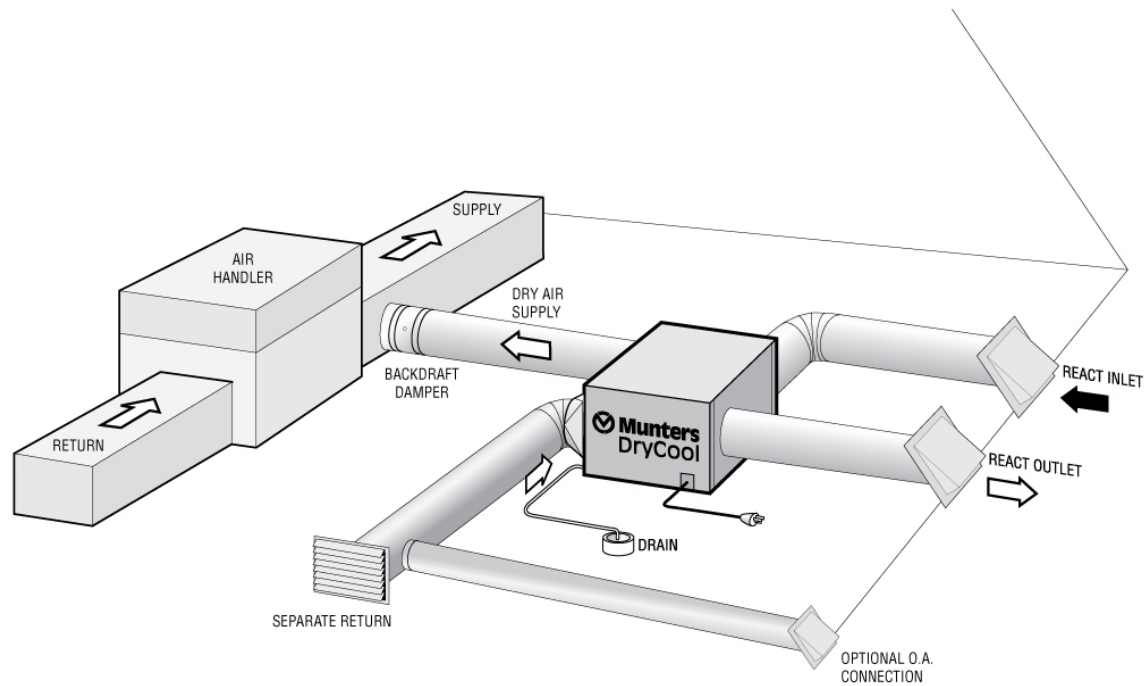

Figure 6: Attic Installation

ALWAYS install a secondary catch pan with a drain or float interrupt for condensate under the DRYCOOL™ HD in an attic.

Locate a separate return for the unit in a central area of the structure or draw air from return ductwork. Duct the supply side of the unit to the air supply of the existing HVAC system. Connect 8" (20.32cm) ducts to the reactivation inlet and outlet to supply ambient air for reactivation and to expel moist air outside the attic.

3.6. Installation for Dehumidification for a Stand Alone Space

One of the benefits of a DRYCOOL™ HD is the delivery of dehumidified air to the space at approximately the same temperature that enters the device. This allows an owner to simplify the installation for applications or instances where it is desired to maintain humidity levels in one open space. In these applications the return air from the space is connected directly to the unit and the dehumidified air can be delivered directly back into the room without the need to mix it with cold air coming from a central air conditioning system.

If the space is a large common room and is open to other adjacent rooms, using the DRYCOOL™ HD can have the effect of providing dehumidification to much larger connected areas or even a small structure. This is because water vapor diffuses from areas of high vapor pressure to areas of low vapor pressure. When large spaces are dehumidified with a unit, areas of low vapor pressure are created and will induce water vapor movement from other connected open rooms without the need for ducting.

Figure 7 shows how the unit draws return air from the common space or a ventilated closet and discharges the dehumidified air back into the space.

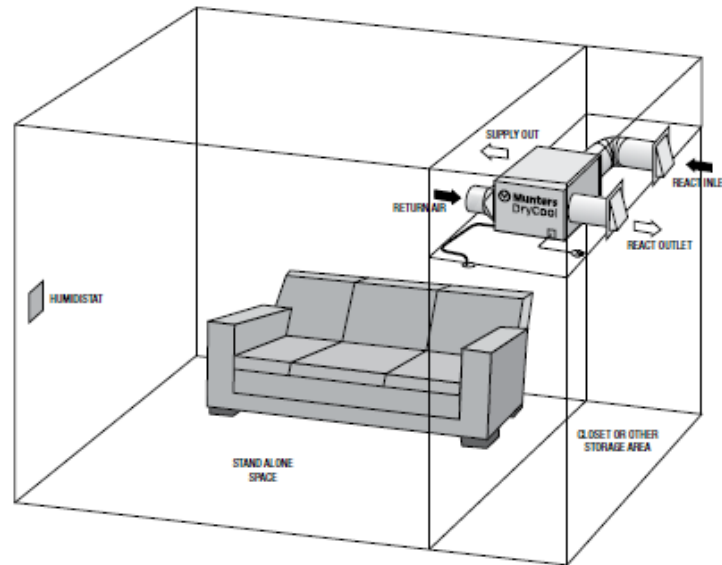

Figure 7: Installation for Stand Alone Space

The DRYCOOL™ HD requires mounting of the remote humidistat away from the discharge in an area that is representative of the larger space. As with all of the installation configurations of a unit, the reactivation air still needs to be ducted to and from outdoors as shown here.

3.7. Humidistat Installation Requirements

Install the remote humidistat in a central area of the structure where it will sense the relative humidity of the structure accurately. Do not install the humidistat where it may not accurately sense the relative humidity such as near HVAC supply registers, near exterior doors, or near a pool or spa. The installer must supply the wiring between the dehumidifier unit and the humidistat. Be sure to safely route the control wires to prevent damage during installation. Be careful not to cross wires when connecting the DRYCOOL™ HD and humidistat or damage to the transformer may result.

The humidistat of the DRYCOOL™ HD is powered by a low voltage circuit and must NEVER contact or be connected to a high voltage circuit. The control wires leaving the unit and the humidistat are color coded to prevent confusion. Be sure to consult the electrical schematic in this manual or the front panel of the unit before making the control connections.

Please **NOTE**: Humidistat is not included. If purchased from Munters the humidistat will be supplied loose with dehumidifier.

3.8. Condensate Removal

**CAUTION**

The DRYCOOL™ HD removes large amounts of moisture from the air and the device must be connected to a drain line that will carry away the excess water. A trap in the drain line is strongly recommended.

1. The unit requires a condensation drain that should be connected to a ¾" (1.905cm) female pipe thread adaptor on the front of the DryCool HD™. Install a proper P-trap in drain line and connect outlet to a suitable drain.
2. The trap must be constructed according to U.M.C. and/or state and local code requirements. Refer to plans and specifications supplied with unit.
3. The trap needs to be primed with water or cleaned prior to start-up and after any extended periods of shutdown.
4. Care should be taken to install the drain line with a continuous slop of 1" (2.54cm) per 10' (304.8cm) to assure proper water removal.

NOTE: The drain trap or its outlet should be checked and cleaned of debris annually or more often if deemed necessary.

An optional condensate pump may be installed if a lift is required to dispose of the condensate. Please consult your local supplier for a condensate pump kit.

**CAUTION**

For additional safety, Munters always recommends that a catch pan with front switch be placed under the DRYCOOL™ HD.

3.9. Optional Germicidal UV Light

An optional active germicidal UVC system can be provided with the Munters DRYCOOL™ HD. UVC is a type of ultraviolet (UVC) energy in the 260-nanometer frequency. The "C" wavelength is the most germicidal in the UVC spectrum. The "C" wavelength targets the DNA of microorganisms, causing cell death or making replication impossible. The UVC energy kills or inactivates microbes, eradicating surface and airborne mold, as well as viruses and bacteria.

UVC is not an air filter. Rather it's a UVC air purification system, based on Steril-Aire's multi-patented technology, used in thousands of schools, hospitals, and government and commercial buildings. This same proven technology is now available for the structure.

The UVC air purification system then uses germicidal action to destroy the mold, bacteria and viruses that grow and circulate in the air, before they travel around your space to trigger allergic reactions or spread disease.

Safety Notices: Improper installation, adjustment, alteration, service, maintenance, or use can cause fire, electrical shock, or other conditions which may cause personal injury or property damage. Consult your local authorized dealer or Munters Corporation for additional information or assistance.

**WARNING**

Before performing maintenance or service on fixture, ensure unit is unplugged. Electrical shock may cause injury or death.

- Never expose eyes or skin to UVC light from any source. Wear gloves, face shield/glasses (per ANSI Z87.1) and cover all exposed skin.
- Do not touch Emitter glass without gloves. Damage to Emitter may result. Oil from fingerprints will permanently etch glass of Emitter. If necessary, clean Emitter using optional cleaning kit.
- Voltages outside of the range designed for the unit will void the warranty and do permanent damage to the entire unit.
- Emitter contains a small quantity of mercury. If an Emitter breaks, clean and dispose with care.

Note: Ensure that emitter is installed before power is applied. Installing emitter after the power has been applied will trigger the “end of lamp life circuit” and emitter will fail to light! If this happens, shut off/de-energize power for 10 minutes and then turn power back on. Emitter will then light.

- Disconnect power from unit
- Remove installation hole plug. This black plastic plug is located on the same end of unit as the control panel and is above the condensate drain outlet.
- Install UVC lamp emitter according to installation instructions included with the emitter.
- Attach UVC emitter power pack to the side of the DRYCOOL™ HD unit with sheet metal screws provided with UVC emitter. Installation location noted in illustration below.
- Plug power supply into the outlet on unit labeled “UV Light”.
- Power can now be reconnected to unit.

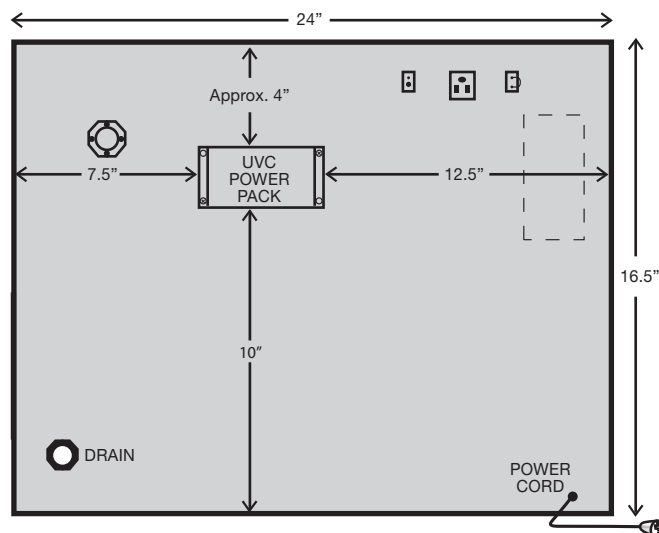

Figure 8: UVC Power Pack Installation

4. Operating Instructions

4.1. Controls

The DRYCOOL™ HD can be equipped with various accessories to enhance its operation. A remote humidistat must be used with the unit.

Please **NOTE**: Humidistat is not included. If purchased from Munters the humidistat will be supplied loose with dehumidifier.

4.1.1. Humidity Control Adjustment

Set the humidity control to the desired humidity level for the structure. Turning knob clockwise on the humidistat results in a drier setting.

The dehumidifier will run continuously until the relative humidity (RH) is reduced to the humidity control dial setting. Setting the humidity control to lower RH levels will NOT increase unit's dehumidification rate; the unit will simply run longer to reduce area's RH to the setting. The DRYCOOL™ HD (and refrigerant based dehumidifiers in general) will reduce a conditioned space's RH to a lower level. Settings below 40% are not recommended.

4.1.2. Fan Switch

Turning the switch to "Fan" position on side of unit will cause only the internal process fan to run continuously. The dehumidification process will still be energized on and off according to the humidistat.

This function is desirable if unit is used for air circulation and filtration to achieve maximum indoor air quality. Air will be constantly filtered through unit and circulated throughout the space. When the switch is set to "Auto", the process fan will operate only when humidity control calls for dehumidification.

The unit, along with either the high efficiency filter and/or the Germicidal UVC, can be used to perform total Indoor Air Quality control for your structure.

4.2. Sequence of Operation

The DRYCOOL™ HD unit utilizes a humidistat to cycle the dehumidification process on and off based on the desired humidity condition.

If the humidity level in the space exceeds the control set point of the humidistat, the unit goes into dehumidification mode and the HoneyCombe® desiccant dehumidifier wheel and DX cooling coil are energized. The desiccant wheel motor is energized to rotate the wheel through the supply and reactivation air streams at a rate of 0.1 RPM. The supply fan draws process air through the evaporator coil and the desiccant wheel. The reactivation air fan is energized to draw a separate air stream through the condenser coil and then through the desiccant wheel. The heat rejected from the condenser coil heats up the reactivation air stream and drives the moisture from the desiccant. This air is discharged to the outside atmosphere. The dehumidification process is continuous as the desiccant wheel rotates through the supply and reactivation air streams. When the humidity in the space returns to its control set point, the desiccant wheel and DX cooling system are de-energized.

It should be noted that the supply fan can be manually switched from "AUTO" to "FAN" by pressing the switch on the side of the unit. Putting the switch in the "Fan" position will keep the supply fan running regardless of whether or not the unit is in dehumidification mode.

5. Maintenance and Service

5.1. Standard Air Filter

The DRYCOOL™ HD is equipped with air filters. These filters should be checked every three months. Operating the unit with a dirty filter will reduce dehumidifier capacity and efficiency and may cause the compressor to cycle off and on unnecessarily based on, or due to, high level pressure.

Under normal circumstances, filters in the unit should be cleaned or replaced quarterly or as labeled. A clean filter is necessary to prevent damage to the dehumidifier and allow it to function at full capacity. To remove the filters, first unplug or de-energize unit, then remove filter(s). To clean properly, flush with warm water and a mild detergent solution or replace filter with new one. The filter sizes are 14 x 14 x 1/(35.56 x 2.54cm (process)), 14 x 16 x 1/(35.56 x 40.64 x 2.54cm (reactivation)) and are available from most local HVAC contractors. Once completed, return power/energize unit and make sure all panels are tightly closed.

To access the air filter, slide the filter out of the side of unit. The filters can generally be vacuumed clean several times before needing replacement. Replacement filters can be purchased locally. DO NOT operate the unit without a filter. The heat exchange coils inside the unit could become clogged and require disassembly to clean.

5.2. Filter Instructions

Please follow all specific instructions as provided by the manufacturer/vendor.

 WARNING	Whenever installing or removing the filter, the power to the unit should be turned off/de-energized and only returned once task is completed.
---	--

5.2.1. Cleaning and/or Replacement Procedures

Filters or media pads should be cleaned and/or replaced depending upon household contaminant conditions. The suggestion is after the first months use they should be cleaned or replaced after initial cleanup of contaminants. Filter can then be placed on a regular maintenance schedule as required. Please follow the procedure listed below.

- Turn the thermostat fan switch to the “OFF” position.
- Turn off/de-energize power to unit.
- Open filter access door or grille.
- Unplug the power supply cord from the air cleaner powerhead.
- Open air cleaner and remove old filter/media pad and discard.
- If dust has accumulated on outer screen of DH unit, clean with a dry brush or vacuum.
- Replace new filter/media pad within center of frame.
- Close air cleaner grille/door.
- Return air cleaner to location in DH unit or return air grille.
- Return power to air cleaner once installed securely.
- Close filter access door or grille.
- Turn thermostat fan back to the “ON” position. (For optimum results, DH unit should be run continuously with the fan switch in the ON position, rather than the “AUTO” position.)

Because of variations in humidity and temperature, the new filter/media pad may make a slight snapping sound when first installed. This is normal and should stop and return to normal within 24 hours of operation.

5.3. Germicidal UVC Lights

Continuously operated emitters need to be replaced annually to maintain design output. As a note, emitter on/off cycles should be minimized in order to maximize emitter life.

No more than an ordinary light bulb - SteriLight's unique Emitters™ are simply changed once a year. SteriLight is virtually maintenance-free between change outs!



CAUTION

Do not look at UVC lights when operating without adequate eye protection. UVC can cause damage to unprotected eyes.

5.4. UV Light Change and Safety Warnings



WARNING

UV Light Safety Warnings:

1. This unit contains a high energy ultra violet C-band (UVC) lamp. The UV radiation on this product is in the highest ANSI/IESNA RP-27.3-07 group, Risk Group 3 (RG-3). Radiation at this level should not be allowed to irradiate human tissue. The UV lamp is to be de-energized before changing the bulb or servicing the dehumidifier. Precautions are to be taken to ensure that service personnel are adequately protected at all times from UV radiation. RG-3 radiation is also present near the inlet of the duct. A minimum of 8 ft (243.84cm) un-perforated ducting is required to be connected to the inlet when the UV light option is used.
2. Ultra violet radiation is present inside unit. Avoid exposure. Always wear protective clothing. Exposure may cause cancer and premature aging of the skin. Always wear protective eyewear. Failure to do so may result in severe burns or long term injury to the eye. Never look directly into lamp. As with natural sunlight, exposure can cause eye and skin allergy or allergic reactions. Medications or cosmetics may increase sensitivity to the UV radiation. Consult a physician before operating this product, if you are using medications or have a history of skin problems or believe yourself especially sensitive to sunlight.

5.5. Troubleshooting

Fan runs with fan switch and ventilation timer OFF, but compressor cycles on & off.

- Low ambient temperature and/or humidity causing unit to cycle through defrost mode.
- Dirty air filter(s) or air flow restricted.
- Defective compressor overload.
- Defective compressor.

Fan does not run with fan switch in either position. Fan does not run with ventilation timer activated.

Compressor runs briefly but cycles on & off with humidity control turned to ON.

- Check for 220V & 24V
- Loose connection in fan circuit.
- Obstruction prevents fan impeller rotation.
- Defective fan.
- Defective fan relay.

Evaporator coil frosted continuously, low dehumidifying capacity.

- Dirty air filter(s) or air flow restricted.
- Low refrigerant charge.
- Dirty evaporator coil

Emitter does not light

- Turn off power for 10 minutes and then turn power back on.
- Check line voltage.
- Check wiring to emitter.
- Replace emitter.
- Replace power supply.

Low Output or visibly weak light

- Replace emitter with new unit.
- Check line voltage.
- Check wiring to emitter.

Red/Orange light

- Check ambient temperature, light will not operate properly below 35°F (1.66° C).
- Follow actions for “Low Output”.

 CAUTION	Servicing the DRYCOOL™ HD with its high pressure refrigerant system and high voltage circuitry presents a health hazard which could result in death, serious bodily injury, and/or property damage. Only qualified service people should service this unit.
--	--

5.6. Recommended Maintenance Schedule

The following table lists recommended maintenance schedules. For detailed instructions on each procedure consult Munters or the appropriate supplier for that part.

5.6.1. Annual Maintenance Schedule

Check This	Location	Monthly	Quarterly	Annually
Inspect Ductwork	Supply Air Outlet/Inlet	✓		
Replace Standard Air Filters	As Labeled		✓	
Replace Electronic Air Filters	As Labeled		✓	
Germicidal UVC Lights	As Labeled within unit			✓
Drain Trap	Per Location			✓

Table 2: Annual Maintenance Schedule

Note: The frequency of all maintenance activities should be adjusted as required per the area of installation. Dirty or dusty environments may require more frequent scheduling of maintenance.

The DryCool HD is designed for basic maintenance access through the rear cover plate and top cover/panel only. If extensive service is required, please return unit to factory (Munters) for service. All filters can be changed without cover/panel removal.

NOTE	The HD Unit is accessible for basic maintenance only, if extensive service is required please return unit to factory (Munters) for service.
-------------	--

The appendix section shows the dimensional drawings for units. Allow specified clearances around the unit on all sides for maintenance access. A 2 ft. minimum is required. Units should have free access to all access panels and doors.

 CAUTION	Servicing the DRYCOOL™ HD with its high pressure refrigerant system and high voltage circuitry presents a health hazard which could result in death, serious bodily injury, and/or property damage. Only qualified service people should service this unit.
--	--

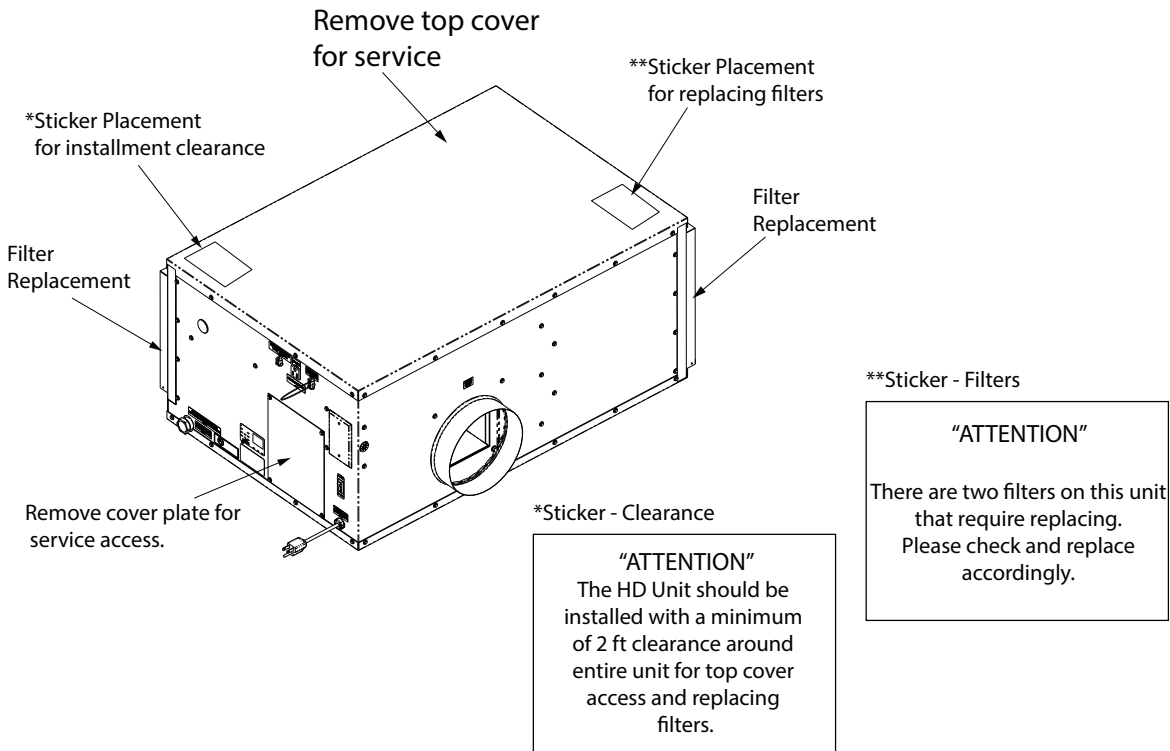

Figure 9: DryCool HD Dehumidifier – Basic Maintenance Access

6. Appendix: Unit Specific Information

Wiring Diagram Sound Level Measurements Fan Curves Dimensional Drawing

Munters Corporation
Tel: (800) 843-5360
E-mail: dhinfo@munters.com
www.munters.us

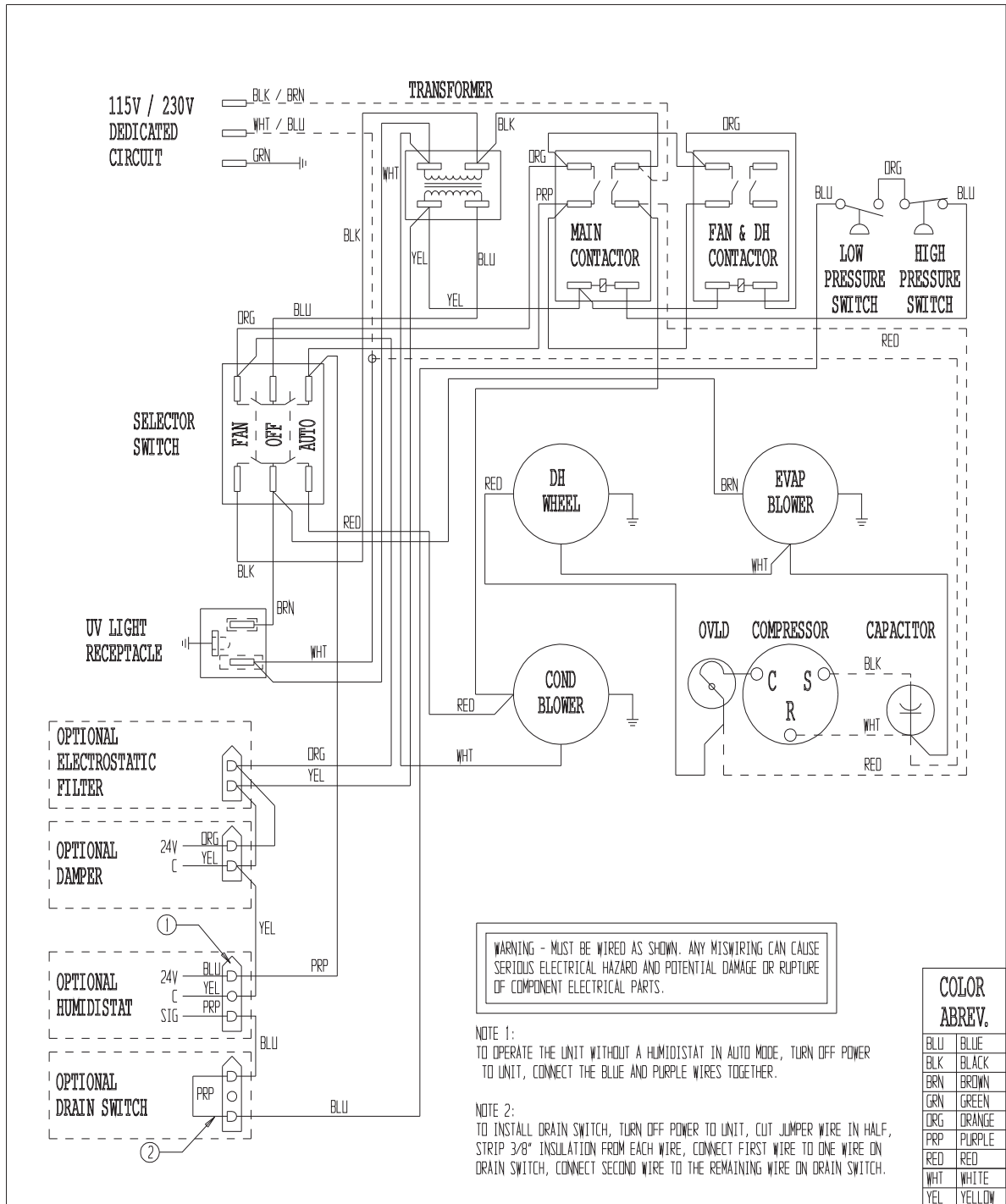
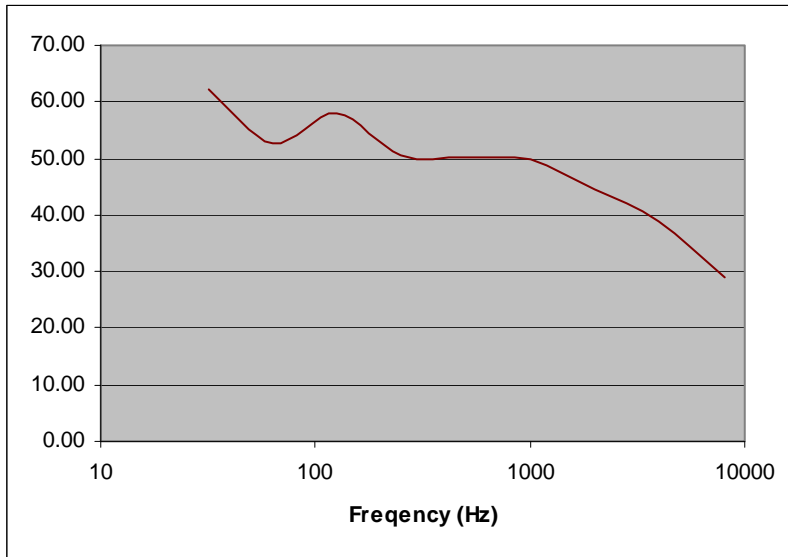

Figure 10: Wiring Diagram Pictorial



DryCool Sound Levels with Background Noise eliminated

Average Sound Levels with Background Noise Eliminated	
Frequency	Level
Broadband	64.17
Broadband	53.57
32	62.24
63	52.79
125	57.86
250	50.46
500	50.20
1000	49.85
2000	44.69
4000	38.82
8000	28.95

Table 3: Average Sound Levels with Background Noise Levels Eliminated

Munters DryCool HD drier testing and analysis for measurement taken on process side of system. Available external Sp measured at 60Hz, 81 deg F (27.22° C) Tro.

Munters Drycool HD Process Side	
Process Airflow ACFM at fan	Available Ext Sp "wg
	60 Hz measured
185.0	0.62
185.0	0.62
213.3	0.53
213.3	0.53
233.6	0.44
233.6	0.44
250.2	0.37
250.4	0.37
275.7	0.26
275.6	0.26
290.4	0.18
290.6	0.18

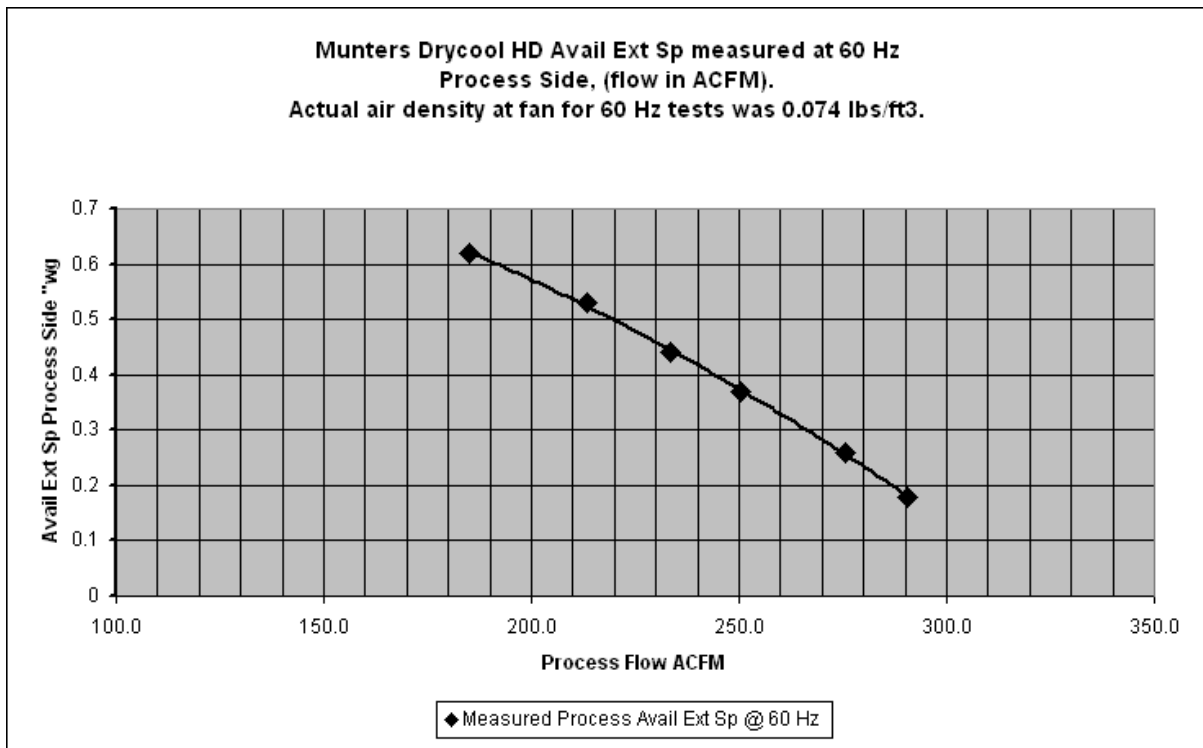

Table 4: Process Fan Flow Measurements

Munters DryCool HD drier testing and analysis for measurement taken on react side of system. Available external Sp measured at 60Hz, 81 deg F (27.22° C) Tro.

Munters Drycool HD React Side	
React Airflow ACFM at fan	Available Ext Sp "wg
	60 Hz measured
294.0	0.24
294.1	0.24
278.8	0.3
278.8	0.3
249.2	0.43
249.2	0.43
228.3	0.5
228.2	0.5
200.7	0.59
200.7	0.59
183.1	0.65
183.1	0.65

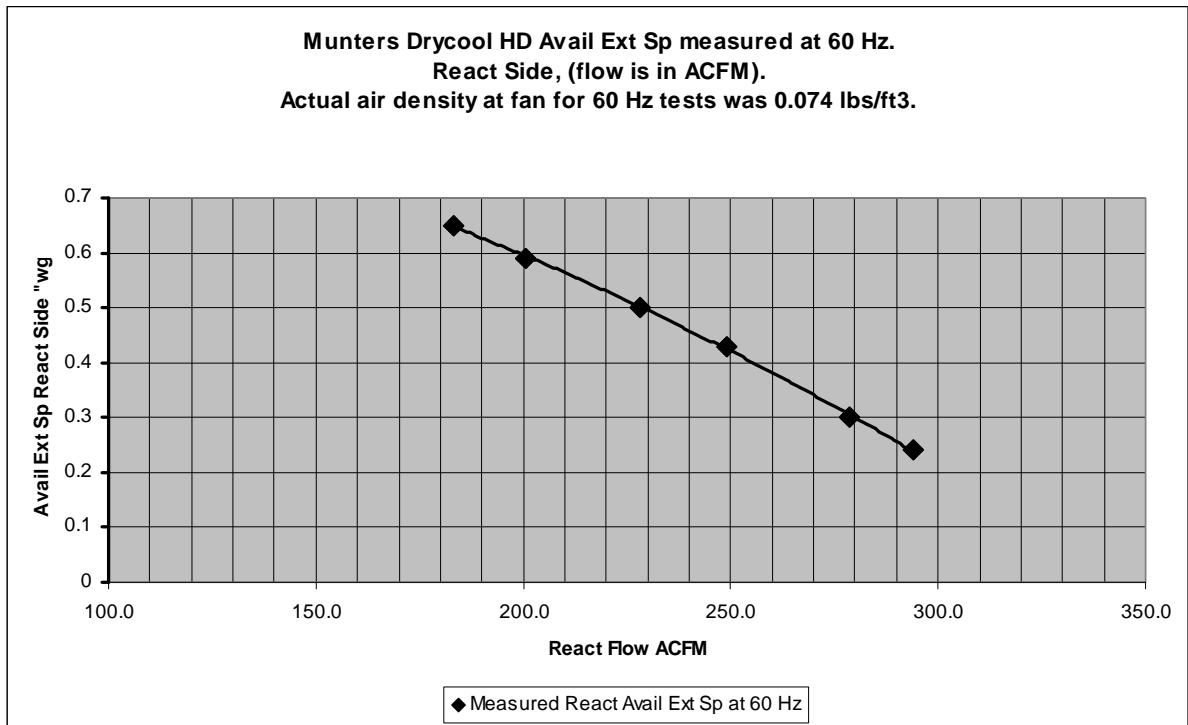

Table 5: React Fan Flow Measurements

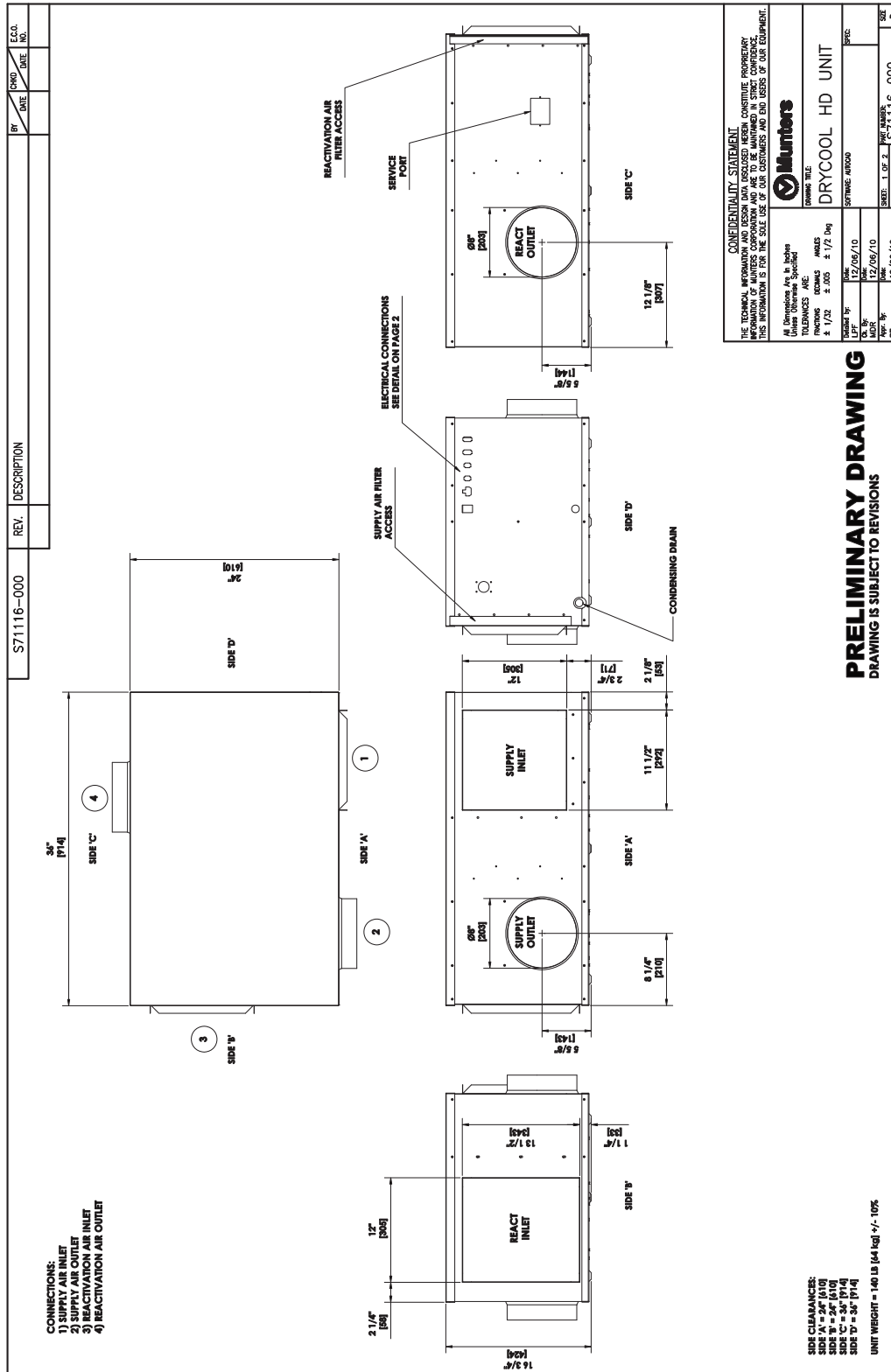

Figure 11: Dimensional Drawing

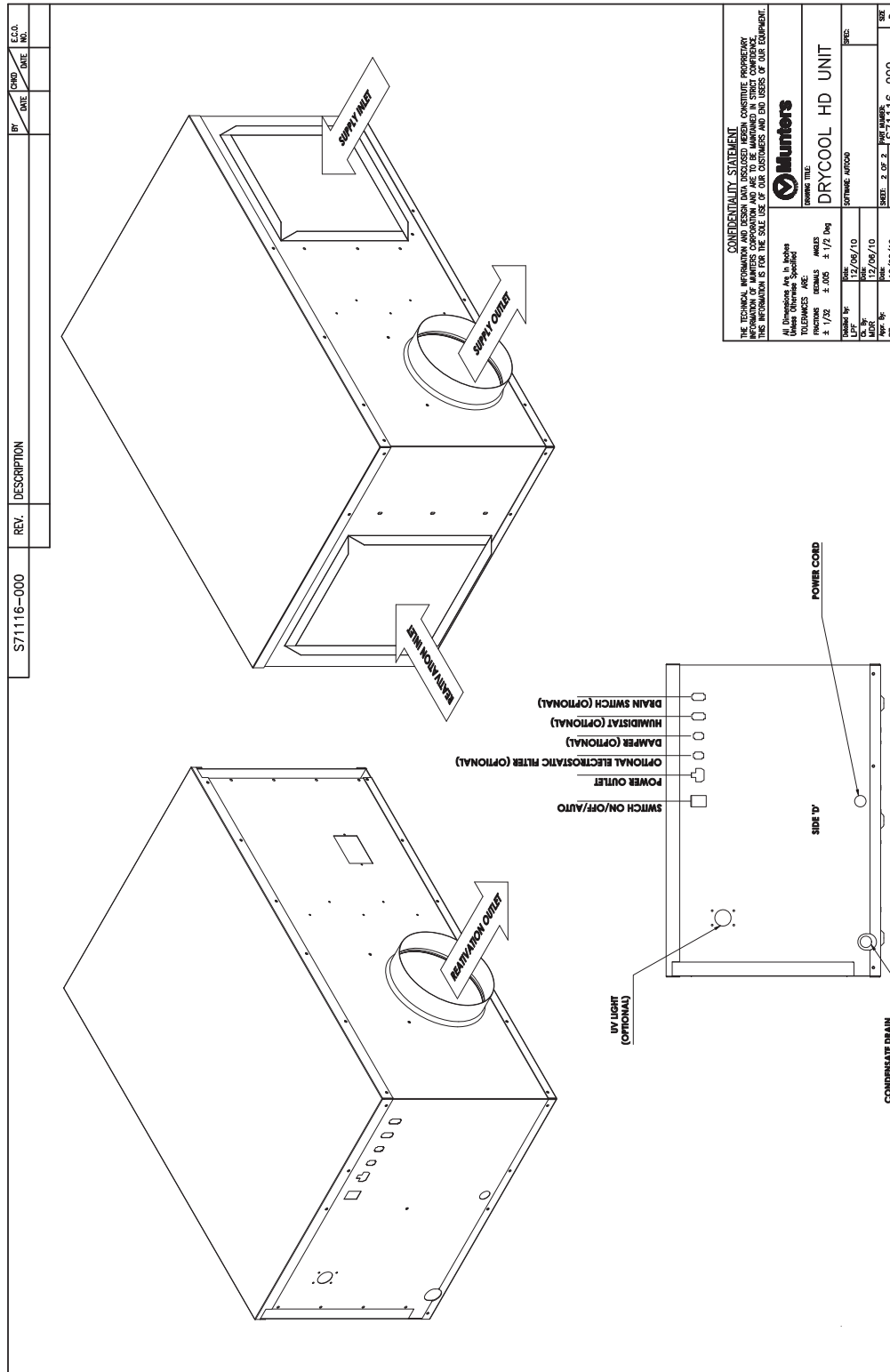

Figure 12: Dimensional Air Flow Drawing

Munters is a global leader in energy efficient air treatment solutions.

Munters manufactures engineered products that can economically control humidity and temperature, provide energy recovery, and/or utilize direct or indirect evaporative cooling for comfort, process and environmental protection. With permanent or temporary solutions, Munters offers a wide variety of options to meet specific climate, application and budget requirements. Munters has net sales approaching \$1 billion USD with more than 20 manufacturing facilities across the globe and sales offices in over 30 countries. Munters employs approximately 4,300 people worldwide.

For more information see www.munters.us

